

Article number: 0101238  
 Description: Retaining ring A 600 DIN 471  
 Spring steel  
 Note: Fitted with ZGA pilers

## Measures

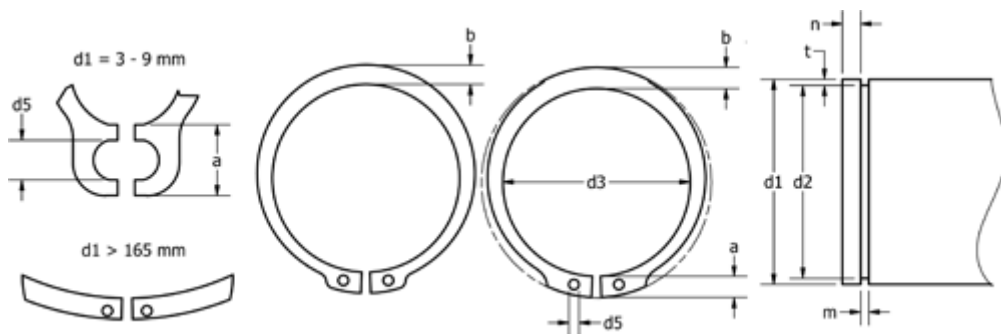

a max	=	FN kN	= 2170.0	s	= 8.00
AN mm <sup>2</sup>	= 13030.0	FRg kN	= 143.00	t	= 7.00
b	= 26.0	FR kN	= 1600.00	tol	= -1.00
d1	= 600	g	= 7.0	tol	= -0.15
d2	= 586.0	K kN-mm	= 3807.00	tol	= +1,50-3,00
d3	= 575.0	m min	= 8.20	Tong	= ZGA-7
d5 min	= 6.0	n abl x 1000	= 0.3	Weight kg/1000	= 999.999
Description	= A600	Nominal drive	= 21.0		